

# SANYO

---

**INSTRUCTION MANUAL**

**CDP-195**

**Portable Compact Disc Player**

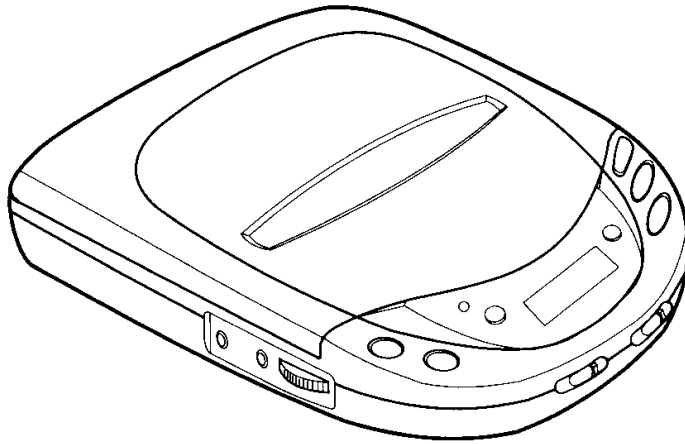

# TABLE OF CONTENT

Safety Certification .....	3
Safety Tips .....	5
Controls .....	6
Power Supply .....	8
Handling Compact Discs .....	11
Playing a Disc .....	12
Programmed Play .....	15
Introsan .....	19
Random Play .....	19
Repeat Play .....	20
Recording From The Line Out Socket .....	21
Cleaning .....	21
Specifications .....	22

**CAUTION:**

Changes or modifications not expressly approved by Sanyo may void the user's authority to operate this equipment.

Remove this protective sheet before use.

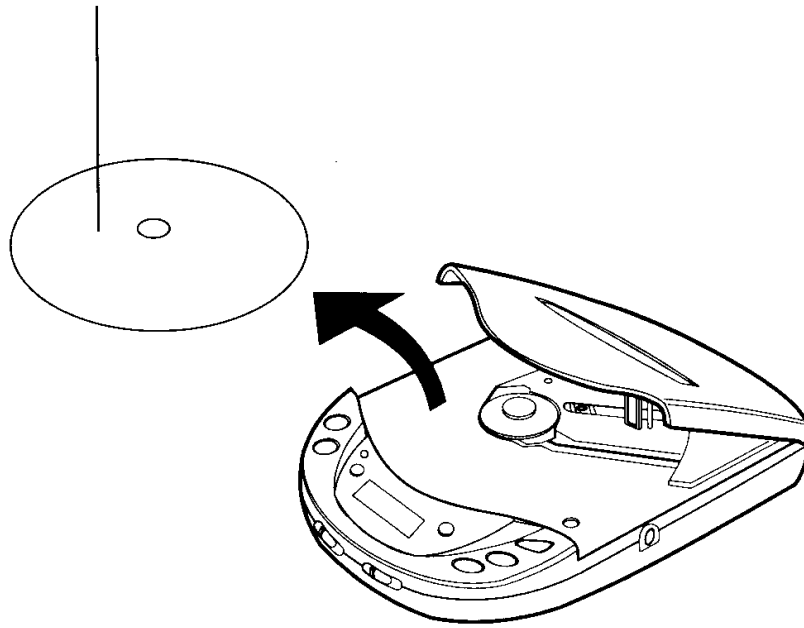

# SAFETY CERTIFICATION

## CAUTION

THIS PRODUCT CONTAINS A LOW POWER LASER DEVICE, TO ENSURE CONTINUED SAFETY DO NOT REMOVE ANY COVERS OR ATTEMPT TO GAIN ACCESS TO THE INSIDE OF THE PRODUCT.

REFER ALL SERVICING TO QUALIFIED PERSONNEL.

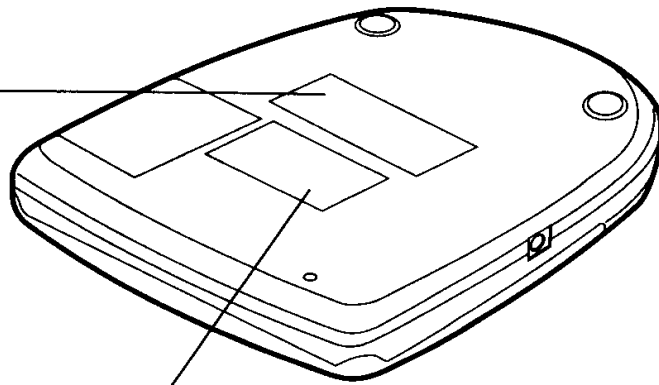
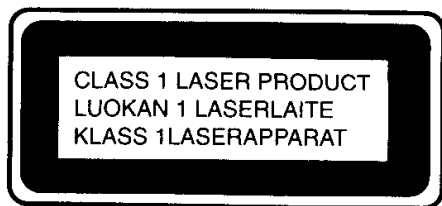

The rating label is located on the bottom of the unit.

## **Hearing Comfort & Well-Being**

- High volume levels can create potentially dangerous situations by drowning out surrounding sounds. Use caution when driving while operating the unit, and obey all applicable laws.
- Do not play your headset at a high volume level. Hearing experts advise against continuous extended play.
- If you experience a ringing in your ears, reduce the volume or discontinue use.

## **Traffic Safety**

- Do not use while operating a motorized vehicle. It may create a traffic hazard and is illegal in many areas.
- You should use extreme caution or temporarily discontinue use in potentially hazardous situations.
- Even if your headset is an open-air type designed to let you hear outside sounds, don't turn up the volume so high that you can't hear what's around you.

## **General**

- Do not place the unit in a position where it will be exposed to magnetic fields, water or sources of heat. Avoid leaving the unit in direct sunlight for prolonged periods.
- It is not recommended to use this unit while bicycling or running.

# SAFETY TIPS

## CAUTIONS FOR SAFETY

- The apparatus shall not be exposed to dripping or splashing.
- Do not take the unit apart.  
The laser beam used in the unit could harm your eyes.
- Do not insert pins, etc., inside the unit. This unit is equipped with a safety device which automatically turns the laser beam off when the disc compartment is opened. If a pin or other metal object should get inside the unit, however, this safety device may be deactivated.
- Do not drop the unit or subject it to strong shocks. Doing so could result in damage.

## Do not place the unit in the following locations:

- Locations where the temperature is high.  
The unit's cabinet may warp or the unit may otherwise be damaged if it is placed in direct sunlight, near heaters (where the temperature is 60°C/140°F or greater) or in cars with the windows closed. (In the summer, the temperature may get as high as 100°C/212°F or more.)  
Use the unit within a temperature range of 5°C/41°F to 35°C/95°F.

- In humid or dusty locations.
- In locations exposed to heavy vibrations.
- On unstable or tilted surfaces.

## CONDENSATION

If cold water is poured into a glass, water droplets form on the outside of the glass. This is called condensation. Condensation may occur on internal operating parts of the lens.

### Condensation occurs:

- When the unit is brought from the cold outdoors into a warm room, or if it is in a cold room which is heated quickly.
- In the summer, if the unit is moved suddenly from an air-conditioned room or car to a hot or humid location.

### Should condensation occur:

The unit may not operate properly if condensation occurs.

Wait for 1 or 2 hours (to allow the internal parts to adjust to the surrounding temperature) before using the unit.

# CONTROLS

1. Disc Compartment
2. OPEN Button
3. Play/Pause Button (▶/⏸)
4. Stop Button(■)
5. P-MODE Button
6. HOLD Switch
7. BASSXPANDER Switch
8. Display
9. M-SET Button
10. Charge Indicator
11. Fast Forward Button(▶▶)
12. Fast Backward Button(◀◀)
13. VOLUME Control
14. LINE OUT Socket
15. PHONES Socket
16. Battery Compartment (bottom)
17. EXT DC 6V Socket

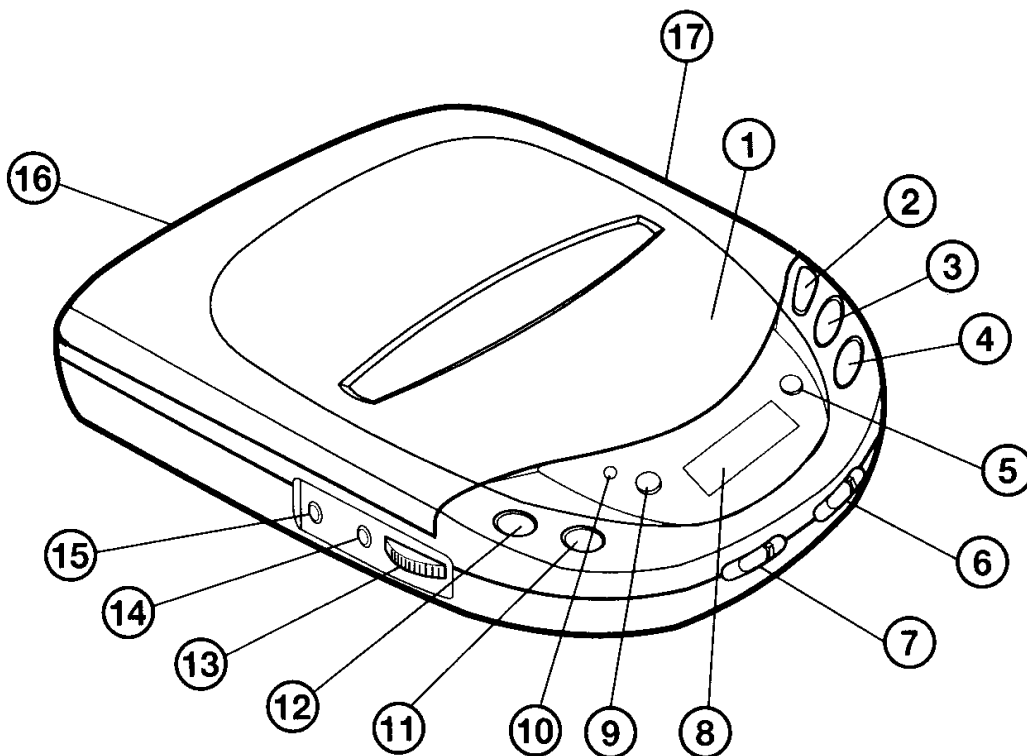

## BASSXPANDER SWITCH

Use the BASSXPANDER switch to increase the bass sound.

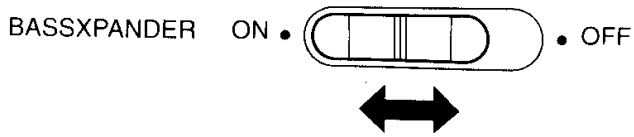

**ON:** To increase the bass sound

**OFF:** Normal sound.

## AUTO POWER ON FUNCTION

The power turns on automatically when the ►/|| button is pressed.

## AUTO POWER OFF FUNCTION

The power turns off automatically when all tracks on a disc have been played or when the ■ button is pressed once to stop play.

- The power turns off automatically after the P-MODE, ◀◀ or ▶▶ button is pressed if no other operation is performed.
- The power turns off immediately after the disc compartment is opened.
- The power turns off immediately if the ■ button is pressed twice during play.

If the ►/|| button, ◀◀ or ▶▶ button is not pressed for approximately 3 minutes after entering the Pause mode, the power turns off automatically.

## HOLD FUNCTION

The HOLD switch disables the buttons from operating to prevent play from starting or stopping due to accidental operation. For normal use, leave the switch in the OFF position.

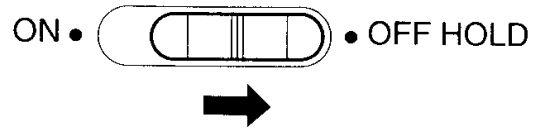

### To prevent battery drain:

Set the HOLD switch to the ON position when carrying the unit in a bag. The unit will not operate even if the buttons are pressed accidentally. This will prevent unnecessary battery drain.

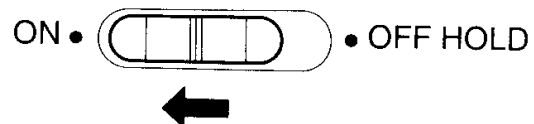

### To prevent play from being interrupted:

Set the HOLD switch to the ON position after starting play. This will prevent interruptions if the ■ button or other buttons are pressed accidentally.

- The VOLUME control will operate regardless of the position of the HOLD switch.



# POWER SUPPLY

## AC ADAPTOR INSTALLATION

Plug one end of the supplied AC adaptor into the EXT DC 6V socket, then plug the other end into a 230V AC wall outlet.

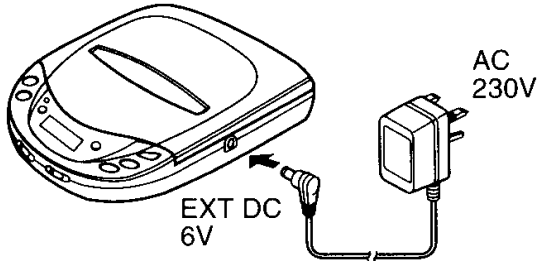

## Cautions on the AC Adaptor

- Use this unit only with the supplied AC adaptor. Use with other AC adaptors could damage the unit.
- Do not touch the AC adaptor with wet hands. Doing so is dangerous, as this could result in an electrical shock.
- If the AC adaptor is connected when the batteries are installed, the power supply automatically switches to the AC power source and the batteries are disconnected.

## RECHARGEABLE NICKEL-CADMIUM BATTERY INSTALLATION

- **Fully charge the rechargeable nickel-cadmium battery before using it for the first time.**

1. Slide the battery compartment on the bottom of the unit to the left, then swing the battery compartment open.

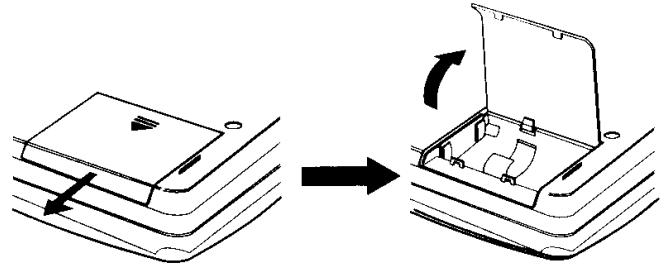

2. Insert the NBP-50A rechargeable nickel-cadmium battery (not supplied) into the battery compartment. Be sure to observe the proper polarity (the “+” and “-” signs, as indicated inside the battery compartment).

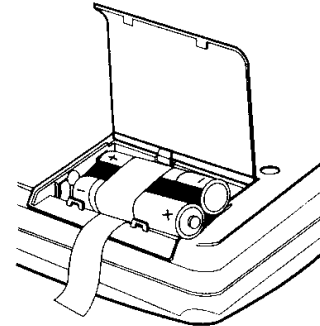

3. Close the battery compartment.
4. The battery is fully charged approximately 10-15 hours after the AC adaptor is connected.
- More time may be required for charging in cold temperatures.
  - You can listen to CDs while the battery is charging, but more time is required for charging.
5. When charging is completed, disconnect the AC adaptor plugs from both the CDP-195 and the AC outlet.

## Notes on the Rechargeable Nickel-Cadmium Battery

- Always keep the charging terminal clean.

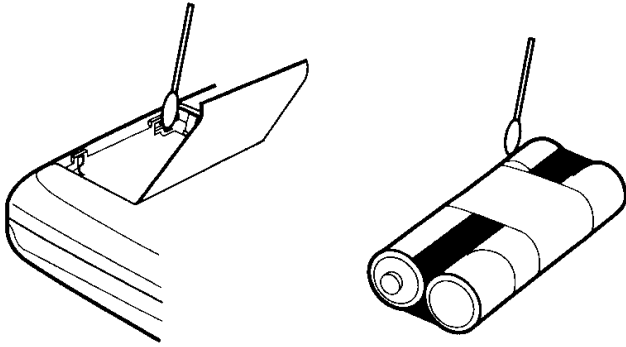

- Do not put rechargeable nickel-cadmium batteries in water or fire.
- Do not disassemble rechargeable nickel-cadmium batteries.

- Only use the NBP-50A rechargeable nickel-cadmium battery with the CDP-195.  
Under normal usage conditions, this battery can be recharged approximately 500 times.  
If a different type of rechargeable battery is installed, it cannot be recharged by the CDP-195.
- If the operating time decreases drastically even when the rechargeable nickel-cadmium battery is properly recharged, purchase a new NBP-50A rechargeable nickel-cadmium battery.
- Do not use any AC adaptor other than the one supplied with the CDP-195.
- Do not charge continuously for 24 hours or more. Doing so can cause the performance of the rechargeable nickel-cadmium battery to deteriorate.
- Do not short-circuit the “+” and “-” terminals of the rechargeable nickel-cadmium battery.

## ALKALINE BATTERY INSTALLATION (not supplied)

Insert two HP7(R6) batteries (not supplied) into the battery compartment on the bottom of the unit. Be sure to observe the proper polarity (the “+” and “-” signs, as indicated inside the battery compartment).

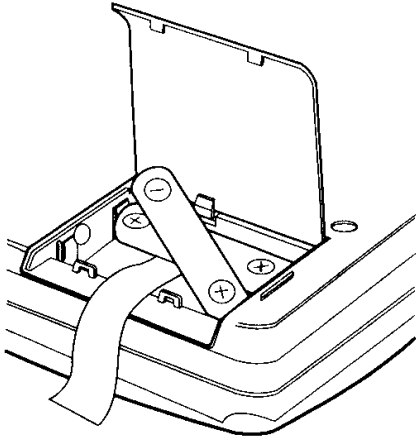

### Notes on Alkaline Batteries

- When replacing the alkaline batteries, use two new batteries of the same type. Do not mix a used battery with a new one or mix different types of batteries.
- When inserting the batteries, mistakenly inserting even one with improper polarity will cause leakage.
- Never charge, heat, disassemble, or throw batteries into a fire.
- When the batteries have become discharged, they must be disposed of in a safe manner that complies with all applicable laws.

### Battery Recharging or Replacement

If the rechargeable nickel-cadmium battery or alkaline batteries are weak and discharged, “” flashes in the display, then the power automatically turns off. If this occurs, recharge the rechargeable nickel-cadmium battery or replace the alkaline batteries before using the unit.

- This unit can be used if the rechargeable nickel-cadmium battery or alkaline batteries are removed, as long as the supplied AC adaptor is connected.
- When you are not going to use the unit for one month or more, take the rechargeable nickel-cadmium battery or alkaline batteries out of the battery compartment.

To remove the rechargeable nickel-cadmium battery or old batteries, press down on one end of the battery so the battery pops out from the compartment.

### NOTE: If the operating buttons do not function when pressed...

1. Check whether the HOLD switch is on or not.
2. Remove the batteries and/or disconnect the AC adaptor from the unit. Wait a few seconds, then reinstall the batteries or reconnect the AC adaptor.
3. If the buttons still do not function, insert new batteries or charge the rechargeable nickel-cadmium battery.

## HANDLING COMPACT DISCS

This unit is designed to play compact discs bearing the identification logo below. Discs that do not carry this logo may not conform to the CD standard and may not play properly.



**Dirty, scratched or warped discs may cause skipping or noise. Pay attention to the following:**

- Handle the disc only by the edges. To keep the disc clean, do not touch the surface of the disc.

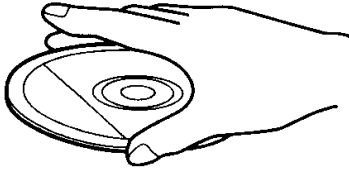

- Discs should be returned to their cases after use to avoid serious scratches that could cause the laser pickup to skip.
- Do not expose discs to direct sunlight, high humidity, or high temperatures for extended periods. Prolonged exposure to high temperatures can warp the disc.

- Do not apply paper or write anything on either side of the compact disc. Sharp writing instruments, or the inks used in some felt-tip pens, may damage the surfaces of the disc.
- Fingerprints should be carefully wiped from the surface of the disc with a soft cloth. Unlike conventional records, compact discs have no grooves to collect dust and microscopic debris, so gently wiping them with a soft cloth should remove most particles. Wipe in a straight motion from the inside to the outside of the disc. Small dust particles and light stains will have no effect on reproduction quality.



- Never use such chemicals as record sprays, anti-static sprays, benzene or thinner to clean compact discs. Such chemicals can damage the plastic surface of the disc.

- The unit will not play a disc that has been inserted upside down, or discs which do not conform to the Compact Disc standard. Also, the unit may not play discs that are scratched, soiled or carry fingerprints.
- 8 cm (3") CDs can be played without an adaptor.

## PLAYING A DISC

- **Be sure to reduce the volume before plugging in or unplugging the headphones.**
- **Be sure to leave the HOLD switch in the Off position.**

1. Plug the cord from a pair of headphones into the PHONES socket.

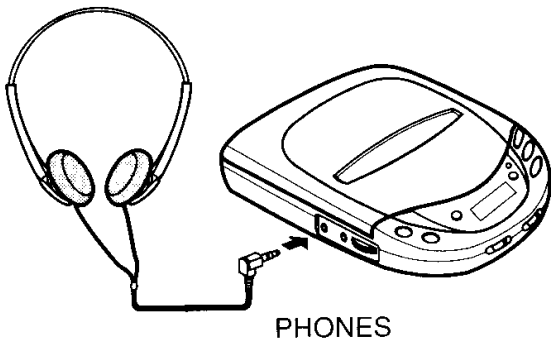

2. Press the OPEN button to open the disc compartment.



3. Hold the disc with the labeled side up and press it onto the spindle until it "clicks" into place.

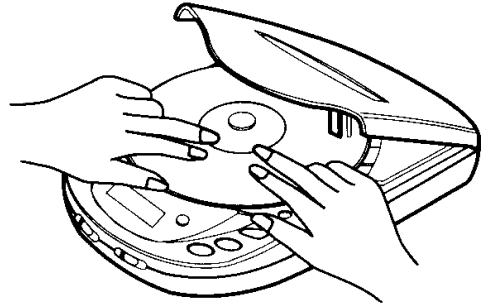

4. Close the disc compartment.

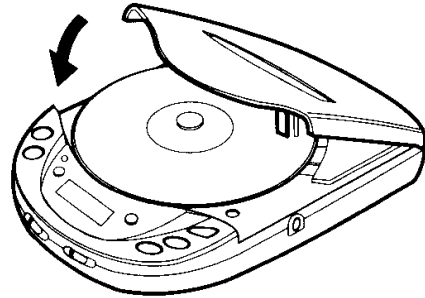

5. Press the ►/|| button to begin play.

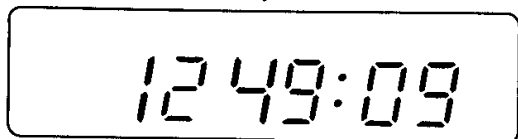
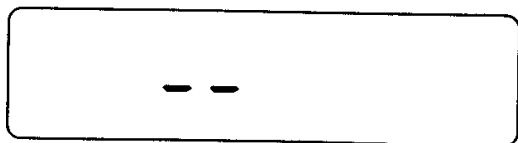
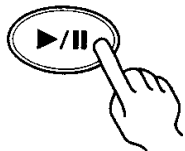

Total number of tracks  
Total playing time on the disc

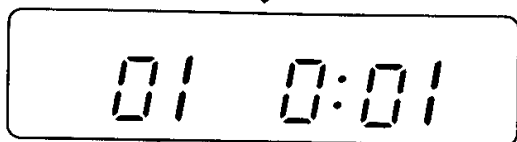

Current track  
Elapsed playing time

6. Adjust the VOLUME control as desired.

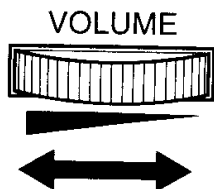

7. Set the following functions according to the usage conditions.

- Bassxpander
- Hold function

8. To stop play temporarily, press the ►/|| button.

- The elapsed playing time flashes in the display.

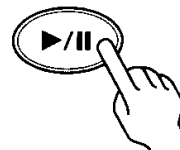

- Press the ►/|| button again to resume.

9. To stop play, press the ■ button once. The total track number and total playing time appear in the display.

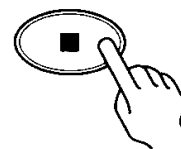

- To turn the power off, press the ■ button once again.
- The power turns off automatically when all tracks on a disc have been played.
- The power also turns off when the disc compartment is opened.

## TRACK SEARCH

Press the **⏮** or **⏭** button during play to skip to the desired track.

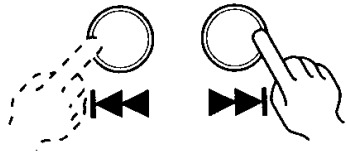

- Press the **⏭** button to skip to the next track on the disc.
- Press the **⏮** button to skip to the beginning of the track currently playing.
- Press the **⏮** button twice or more to skip to previous tracks.

## FORWARD/REVERSE SEARCH

Press and hold the **⏮** or **⏭** button during play to scan the disc at high speed. When the desired section of the disc is found, release the button. Normal play will resume.

**⏭** button.....FORWARD  
**⏮** button .....REVERSE

- If you press and hold the **⏭** button while the last track is playing, and the end of the track is reached, the player stops.
- If you press and hold the **⏮** button while the first track is playing, normal play automatically begins from the beginning of the first track.

# PROGRAMMED PLAY

- The tracks on the disc can be programmed for play in any order. (Up to 22 tracks can be programmed.)
- During programming, the track number and “**M**” will flash in the display.

## Program Example:

Program Number	1	2	3	4	5	6			
Track Number	5	3	8	1	2	4			

1. Press the P-MODE button six times during play.

P-MODE



2. Press the |◀◀ or ▶▶| button to select track number 5.

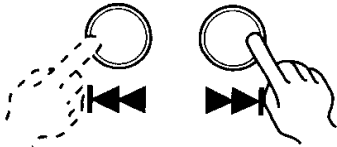

Track number

Program number

3. Press the M-SET button. Track 5 is now programmed.

M-SET



4. Repeat steps 2 and 3 to program other tracks.
- Programmed play automatically begins if you program 22 tracks.



- To check the program contents after all track numbers have been programmed, press the M-SET button. The programmed track numbers will be displayed in the order they were memorized.

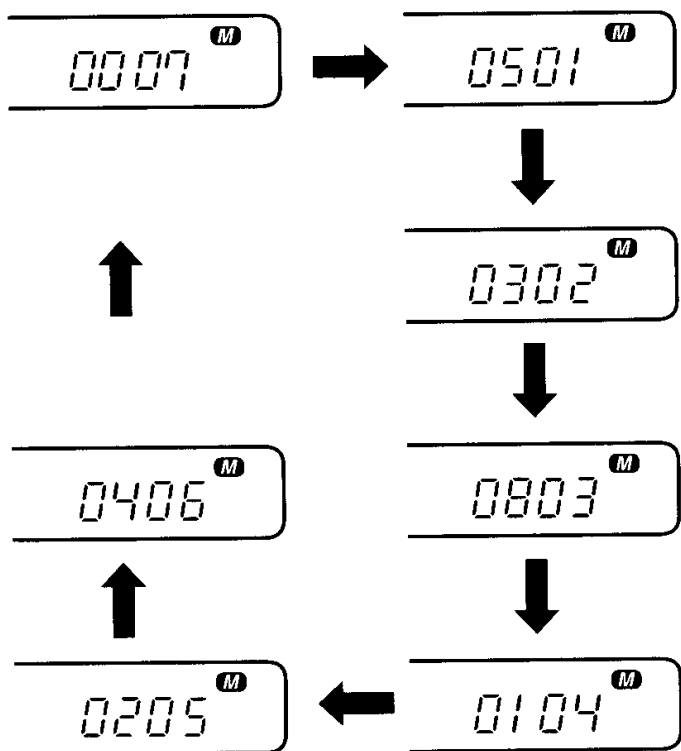
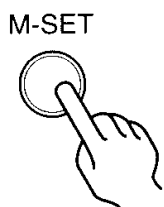

- After programming is finished, press the ►/|| button.

- “**M**” stops flashing in the display and programmed play begins.

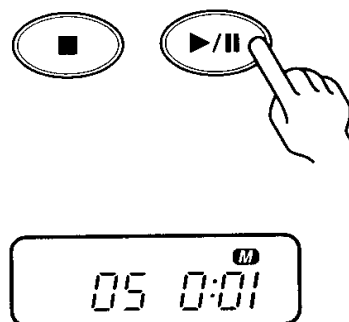

- The unit stops automatically after all programmed tracks have been played.
- The programmed tracks are stored in memory until the disc compartment is opened or the power is turned off. To play the same program again, press the P-MODE button to display “**M**”, then press the ►/|| button.

## Program Example:

Program Number	1	2	3	4	5	6			
Track Number	5	3	8	1	2	4			

### Changing the Program

Press the P-MODE button to display “**M**”. The track number and “**M**” flash in the display.

**Example:** To change program 2, track number 3 to track number 6

1. Press the M-SET button to display track number 3 (program number 2).



2. Press the |◀◀ or ▶▶| button to change the track number to 6.



3. Press the M-SET button. After the change has been completed, the display will change to indicate the next program number (track number 8, program number 3).



### Adding a Program

Example: Add track number 9 as program 7

1. Press the M-SET button to display “00 07”.



2. Press the |◀◀ or ▶▶| button to display track number 9.

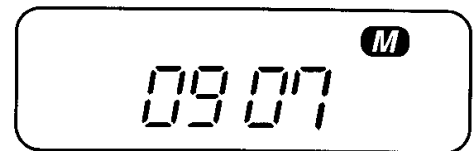

3. Press the M-SET button. After the addition is completed, the display will indicate “00 08”.

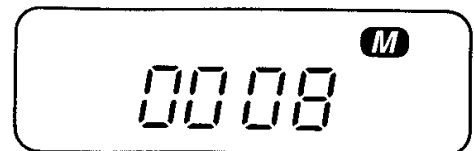

4. To make further additions, repeat the same procedure: press the |◀◀ or ▶▶| button to display the track number, then press the M-SET button.

## Changing the Last Portion of a Program

**Example:** Change the programming from program 4 onward

1. Press the M-SET button to display track number 1 (program number 4).

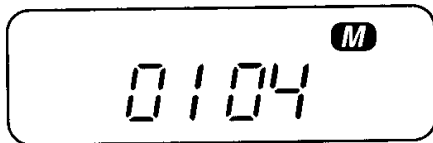

2. Press the |◀◀ or ▶▶| button to set the track number display to "00".

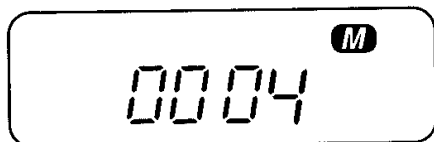

3. Press the M-SET button to delete program 4 and the following programs. The display will indicate track number 5 (program number 1).

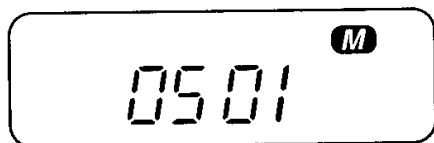

4. Press the M-SET button to display "05 01".
5. Program subsequent entries using the following procedure: press the |◀◀ or ▶▶| button to display the track number, then press the M-SET button.

## Deleting the Program

1. Press the M-SET button to select track number 5 (program number 1).

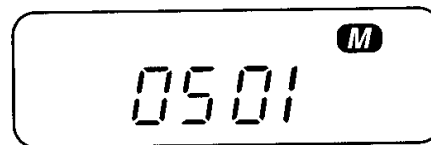

2. Press the |◀◀ or ▶▶| button to set the display to "00 01".

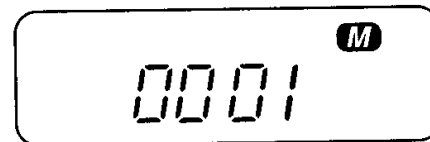

3. Press the M-SET button and the entire program will be deleted.

## The programs will be lost in the following circumstances.

- When the disc compartment is opened.
- When the rechargeable nickel-cadmium battery or the alkaline batteries are exhausted.
- When the rechargeable nickel-cadmium battery or the alkaline batteries have not been installed and the AC adaptor is disconnected.

## Normal play without erasing the program

1. Press the P-MODE button during programmed play. When the "M" display goes out, normal play resumes.
2. To return to programmed play, press the P-MODE button to display "M", then press the ▶/|| button.

# INTROSCAN

1. Press the P-MODE button three times during play to select the introscan play mode.
  - "INTRO" flashes in the display.
2. Press the ►/|| button .
  - "INTRO" lights in the display.
  - The first 10 seconds of each track on a disc are played from the first track.

P-MODE

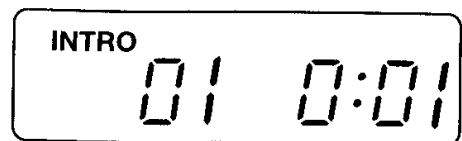
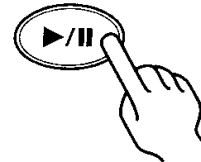
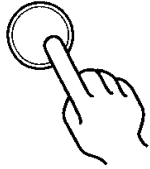

# RANDOM PLAY

Press the P-MODE button four times during play.

- "RANDOM" appears in the display. All tracks on the disc are played in random order.

P-MODE



# REPEAT PLAY

## SINGLE TRACK REPEAT

Press the P-MODE button once during play.

- “ 1” appears in the display.

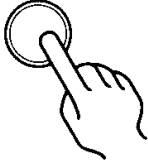

P-MODE



Track number which is repeated

## PROGRAM REPEAT

1. Press the P-MODE button five times during play.

- “” appears, and “00” and “” flash in the display.

P-MODE

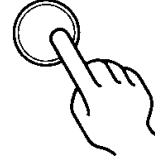

## ALL TRACKS REPEAT

Press the P-MODE button twice during play.

- “ ALL” appears in the display.

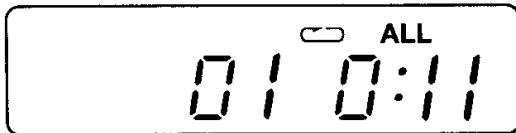

2. Follow steps 2 ~ 6 under “PROGRAMMED PLAY” (page 15).

## RECORDING FROM THE LINE OUT SOCKET

The output from the CD player can be recorded.

Connect a patch cable (supplied) from the LINE OUT socket on the CD player to the LINE INPUT sockets on a cassette recorder.

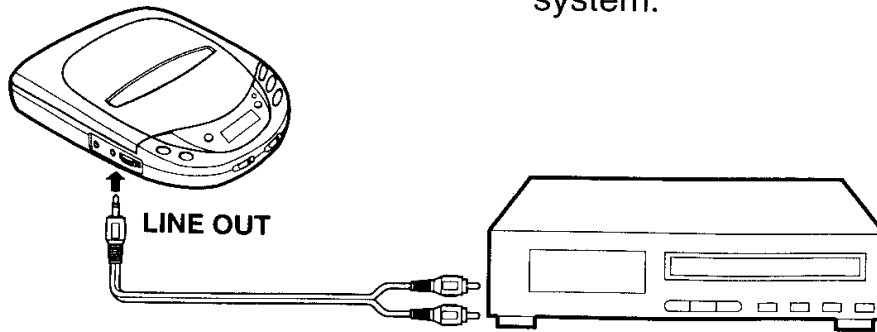

The sound from the CD can be heard through a pair of speakers.

Connect a patch cable (supplied) from the LINE OUT socket on the CD player to the AUX or CD INPUT sockets on a stereo system.

## CLEANING

### CLEANING THE PICKUP LENS

Dust on the pickup lens can lead to erratic operation and interruption of the sound during play.

- To clean the pickup lens, open the disc compartment. Blow the dust off of the lens using a camera lens blower (available at most camera stores).
- Do not touch the surface of the lens.

Never use benzol, benzene or other strong chemical cleaners, since these could damage the finish. It is important that no liquid reaches the inside of the unit.

### CLEANING THE CABINET

Use a soft cloth moistened with plain lukewarm water and wrung dry.

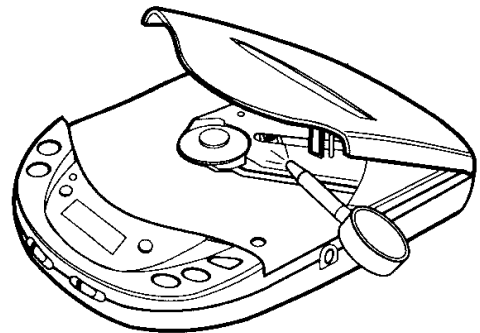

# SPECIFICATIONS

## CD Player Section

Channels:

2 channels

S/N ratio:

60dB

Wow & Flutter:

undetectables

Sampling frequency:

44.1 kHz

D/A Converter:

1-bits

Pick up light source:

Semi-conductor laser

Pick up wave length:

790 nm

Laser output:

Continuous wave max. 0.5mW

## General

Terminal impedance:

PHONES: 16-32 ohms

LINE OUT: 47 kohms

Power source:

AC Adaptor: AC 230V, 50 Hz

DC: 3V (Ni-Cd battery NBP-50A  
or HP7 x 2)

Dimensions:

133 x 28 x 158mm (W x H x D)

Weight (approx):

270g without batteries

Accessories:

AC adaptor x 1,

Headphones x 1,

Patch cable x 1

Specifications subject to change without notice.

## **GUARANTEE TO CUSTOMER**

Sanyo U.K. Sales Ltd. (the Company) guarantees to the initial retail purchaser that if this equipment is or becomes defective and that, in the opinion of the Company, the defect is due to faulty material or workmanship the Company will, for a period of 12 calendar months from the date of sale to the original purchaser repair or replace, at its sole option, free of charge, any such defective component part of the equipment, always provided that:-

1. The equipment has at all times been used in accordance with the operating instructions issued by the Company, and has not been connected to an electrical mains supply for which it has not been adjusted.
2. Accidental damage, or damage caused by negligence or misuse by the user, including leakage from exhausted batteries, is specifically excluded.
3. Unauthorised repairs, or any modification to the equipment which has not been expressly approved by the Company, shall render this guarantee null and void.
4. Failure due to fair wear and tear of any item, such as batteries, record playing styli, and tape recording, playback and erase heads is specifically excluded.

This guarantee is not transferable and is only applicable within the United Kingdom (and the Republic of Ireland).

Nothing in this express guarantee affects the statutory rights available to the purchaser of this equipment.

Note: This guarantee supersedes any other form of guarantee that may inadvertently have been enclosed with or attached to the product. (August 1978).

*Dear Customer*

Thank you for buying Sanyo. This equipment should give you many years of pleasure and faithful service but in the event that a fault occurs, the following notes for your guidance may be helpful:-

1. PLEASE RETAIN YOUR PURCHASE RECEIPT WHICH WILL BE REQUIRED FOR SERVICE DURING GUARANTEE.
2. If your Sanyo equipment proves faulty during the period of guarantee, take it or send it back to the dealer who originally supplied it together with this guarantee and the proof of purchase. We have made arrangements with our approved dealers under which they will carry out inguarantee service repairs on our behalf. In this way, we hope to reduce to a minimum the amount of time you will be without your equipment.
3. If for some reason it is impossible to return the equipment to the original supplies, please contact our Consumer Relations Department at the address below for further advice.
4. Should the equipment require servicing after the expiry of the guarantee period, take or send it to the original supplier or any other Sanyo dealer. He will be pleased to give you a quotation for the repair. If you are in any doubt about what to do, write to us at the address below or telephone:

**Consumer Relations Department,  
Sanyo U.K. Sales Ltd.,  
Sanyo House  
Otterspool Way, Watford,  
Hertfordshire WD2 8JX  
Tel: Watford 246363**

R4

1AD6P1P0691-A  
(UK)

**SANYO**

**SANYO Electric Co., Ltd.**